

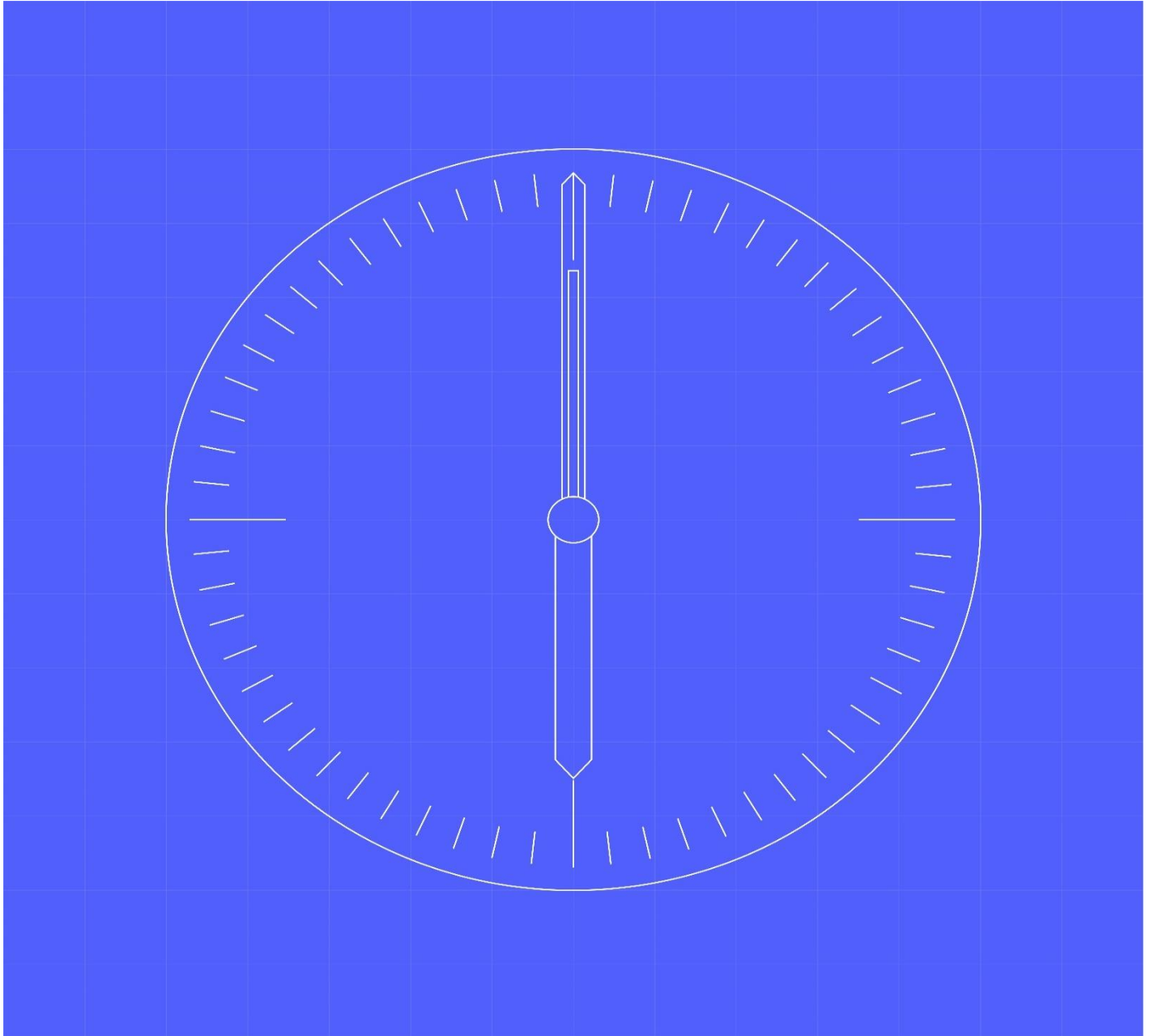

# [04] Migration Requirements and Processes



Document owner

**MHHS Programme**

Status:

**Interim Approved by MCAG**

Document number

**MHHS-DEL2430**

Date

**25 February 2025**

Version

**3.0**

Classification

**Public**



# 1 Contents

<b>1</b>	<b>Contents</b>	<b>1</b>
1.1	Table of Figures	2
1.2	Change Record	3
1.3	References	3
1.4	Terminology	4
<b>2</b>	<b>Introduction</b>	<b>5</b>
2.1	Document purpose	5
2.2	Scope of this Document	6
<b>3</b>	<b>Intended Audience</b>	<b>6</b>
<b>4</b>	<b>Migration framework</b>	<b>7</b>
<b>5</b>	<b>High Level Requirements</b>	<b>8</b>
5.1	Summary	8
5.2	High-Level Requirements	9
<b>6</b>	<b>Business Process Models</b>	<b>10</b>
6.1	Level 0: MCC and Migration Schedule	10
<b>7</b>	<b>Level 1: 01 Initialise Schedule-(BPM)</b>	<b>12</b>
7.1	Level 1: 01 Initialise Schedule-(BPM Descriptions)	13
<b>8</b>	<b>Level 1: 02 Maintain Schedule-(BPM)</b>	<b>14</b>
8.1	Level 1: 02 Maintain Schedule-(BPM Description)	15
<b>9</b>	<b>Level 1: 03 Manage Sprint Execution (BPM)</b>	<b>17</b>
9.1	Level 1: 03 Manage Sprint Execution-(BPM Description)	18
9.2	Level 2: 03.01 Monitor Sprint (BPM)	19
9.3	Level 2: 03.02 Manage Sprint (BPM)	21
9.4	LEVEL 3: Ad-Hoc Unused Capacity Allocation (Process Description)	23
9.5	Level 2: 03.03 Control Sprint (BPM)	24
<b>10</b>	<b>Level 1: 04. Data Analytics and Reporting (BPM Description)</b>	<b>27</b>
<b>11</b>	<b>Level 1: 05. Close Down Migration (BPM)</b>	<b>28</b>
11.1	Level 1: 05. Close Down Migration (BPM Description)	28
<b>12</b>	<b>Appendix</b>	<b>30</b>
12.1	MHHS Migration Business Process Model Notation Key	30

**1.1 Table of Figures**

Figure 1 - Migration Framework Document architecture .....5  
Figure 2 - Level 0 Business Process Model for MCC and Migration Schedule .....10  
Figure 3 - Level 1 BPM - 01-Initialise Schedule .....12  
Figure 4 - Level 1 BPM - 02 Maintain Schedule .....14  
Figure 5 - Level 1 BPM - 03 Manage Sprint Execution .....17  
Figure 6 - Level 2 BPM – 03.01 Monitor Sprint.....19  
Figure 7 - Level 2 BPM – 03.02 Manage Sprint.....21  
Figure 8 - Level 2 BPM – 03.03 Control Sprint .....24  
Figure 9 - Level 1 BPM – 05 Close Down Migration.....28  
Figure 10 - Business Process Model Notation Key .....30

## 1.2 Change Record

Date	Author	Version	Change Detail
18/03/2024	Migration Team	v0.1	Draft for Industry Consultation
19/02/2024	Migration Team	v0.2	Revised Draft for Assurance Meeting
08/05/2024	Migration Team	V1.0	Version Uplifted following MCAG Interim Approval
13/06/2024	Migration Team	V1.1	Draft for Industry Consultation 2
28/06/2024	Migration Team	V1.2	Updated following Industry Consultation comments
25/07/2024	Migration Team	V2.0	Version Uplifted following MCAG Interim Approval
20/12/2024	Migration Team	V2.1	Draft for Consultation 3
31/01/2025	Migration Team	V2.2	Updated following Consultation 3 Industry Review
25/02/2025	Migration Team	V3.0	Interim Approved by MCAG

## 1.3 References

Document	Publisher	Published	Additional Information
REF-1 MHHS-DEL2426-[01] Migration Framework Foundations v3.0	Migration Team	25/02/2025	Migration FW
REF-2 MHHS-DEL2427-[02] Migration Framework - Principles and Guidelines v3.0	Migration Team	25/02/2025	Migration FW
REF-3 MHHS-DEL2428-[03] Migration Capacity Calculations - Method Statements v3.0	Migration Team	25/02/2025	Migration FW
REF-4 MHHS-DEL2429-[03a] Calculations Monitoring and Control – Parameters v3.0	Migration Team	25/02/2025	Migration FW
REF-5 MHHS-DEL2430-[04] Migration Requirements and Processes v3.0	Migration Team	25/02/2025	Migration FW
REF-6 MHHS-DEL2431-[04a] Migration Business Process Models v3.0	Migration Team	25/02/2025	Migration FW
REF-7 MHHS-DEL2762-[05] Migration Choreography v3.0	Migration Team	25/02/2025	Migration FW
REF-8 MHHS-DEL2763-[06] Migration Governance and Escalation Framework v3.0	Migration Team	25/02/2025	Migration FW
REF-9 MHHS-DEL2764-[07] Migration Data Requirements and Reports v3.0	Migration Team	25/02/2025	Migration FW
REF-10 MHHS-DEL961 – Migration Design Document v1.4	Migration Team	12/06/2024	
REF-11 MHHS-DEL953 – Data Assessment Report v1.0	Migration Team	21/02/2023	
REF-12 MHHS-DEL1128 – Migration, Cutover and Data Strategy v1.0	Migration Team	02/06/2023	
REF-13 MHHS-DEL1648 - Migration Thresholds Document v2.0	Migration Team	25/02/2025	
REF-14 MHHS-DEL813 – Overarching Test Data Approach and Plan v1.0	Testing Team	19/07/2023	
REF-15 MHHS-DEL1181 – Data Cleanse Plan v3.0	Migration Team	09/08/2024	
REF-16 MHHS-DEL1792 - M15 Acceptance Criteria v2.0	Migration Team	25/02/2025	
REF-17 MHHS-DEL3359 – Terminology and Glossary v3.0	Migration Team	25/02/2025	Migration FW

## 1.4 Terminology

Please see MHHS-DEL3359 – Terminology and Glossary v3.0

---

## 2 Introduction

### 2.1 Document purpose

This document should be read in conjunction with the supporting artefacts.

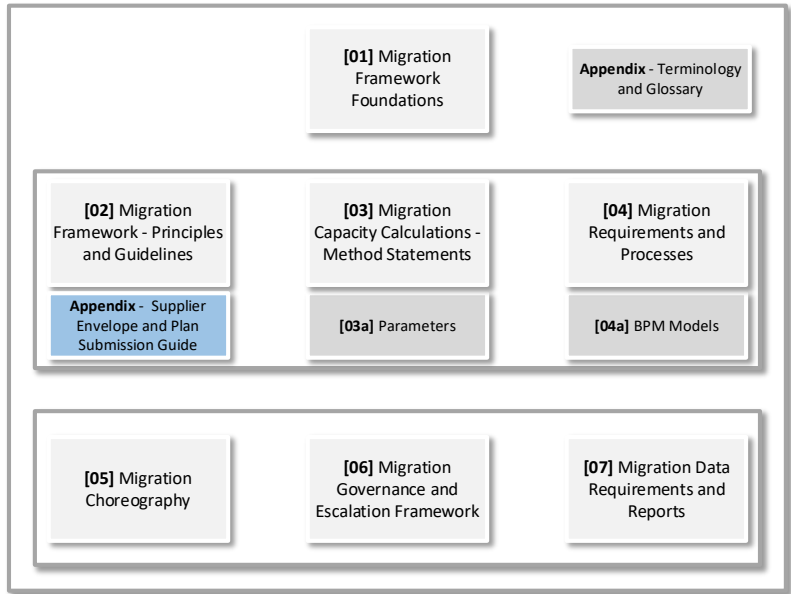

Figure 1 - Migration Framework Document architecture

The key activities to be described by the Migration Framework that will subsequently be managed by the Migration Control Centre will be the Initialisation of the Migration Schedule and its maintenance thereafter in response to changes to circumstances i.e. changes to qualification timelines and deviation from schedule.

This document, and supporting documents as listed in the References section, together with the migration timetable, form the MHHS Migration Plan that details the obligations, as defined in Section C12 of the Balancing and Settlement Code Section C, that defines the obligations on MHHS Market Participants relating to participation in the Migration of MHHS Metering Systems.

## 2.2 Scope of this Document

The MHHS Migration Framework has 5 components, this document version currently covers the components below.

#	Component	Included in document
01	Initialise Schedule	Yes
02	Maintain Schedule	Yes
03	Manage Migration Sprint	Yes
04	Data Analytics and Reporting	Yes
05	Close Down Migration	Yes

## 3 Intended Audience

These parties are:

- The Registration Services (including Service Providers);
- Suppliers;
- Data Collectors / Aggregators;
- Meter Operators;
- The DIP Service Provider;
- Metering Services (i.e., MSS, MSA);
- Data Services (i.e., SDS, ADS, UMSDS);
- EES;
- LDSOs (i.e., DNOs and iDNOs);
- Meter Administrators;
- The DCC, operating Smart Metering and CSS;
- ESO;
- Elexon Central Services (ECS);
- Electralink (DTN);
- REC and BSC Performance Assurance Boards; and
- UMSOs.

## 4 Migration framework

To manage the migration complexities and set the Migration phase up for a success a Migration Framework is required. The Framework will be developed and agreed with industry and will guide the Migration Control Centre activities.

The Migration framework comprises of 5 components.

#	Component	Description
01	<b>Initialise Schedule</b>	Steps to develop and agree v1 of schedule. Setting up the initial migration plan, factoring in all Supplier Weekly Migration Plans to establish a feasible MHHS Migration Schedule for all Participants.
02	<b>Maintain Schedule</b>	After the creation of the v1 of schedule. Regular updating and adjusting the MHHS Migration Schedule to reflect changes such as Qualification Date, ensuring it remains realistic and achievable. During Migration Window factoring in Supplier progress and outturn to further inform MHHS Migration Schedule feasibility and make necessary adjustments.
03	<b>Manage Sprint Execution</b>	Monitoring and managing execution according to the Daily MHHS Migration Schedule. Reviewing MHHS Migration Schedule vs Actual Supplier Migration performance, identifying, and addressing deviations promptly. Managing migration constraints, risks and resolving issues. Apply rules to determine need for measures and/or escalations according to the Migration Governance Framework. Manage in-flight allocation of unused capacity in response to control measures.
04	<b>Data Analytics and Reporting</b>	Analyse migration data to provide insights and regular reports on migration progress, challenges, and achievements. Includes the collection, aggregation, analysis, and dissemination of migration data, reports and analytics to support a data-led decision-making and control process for MHHS Migration.
05	<b>Close Down Migration</b>	Close-down reporting and decommission MCC, and finalise documentation.



## 5 High Level Requirements

### 5.1 Summary

#### Industry Participants / Roles

Participant Type	Role
Energy Suppliers	Suppliers
Data Service Providers	Agents
Metering Agents	
Distributors (DNOs / iDNOs)	LDSOs
Regulatory Bodies	Code Bodies
Consumers	Customers

#### 5.1.1 Migration Participants / Roles

Role	Description
Migration Control Centre	<p><b>Pre-M10</b></p> <ul style="list-style-type: none"> <li>Set-up framework and foundation for migration to MHHS</li> </ul> <p><b>Post M10</b></p> <ul style="list-style-type: none"> <li>Oversight of MHHS Migration Programme execution during migration window</li> <li>Transition to BAU</li> </ul> <p><b>Post M15</b></p> <ul style="list-style-type: none"> <li>Close down of MCC</li> </ul>

## 5.2 High-Level Requirements

This section covers fundamental expectations and objectives for all stakeholders involved in the MHHS Programme's migration process. It serves as a blueprint for future discussions and more detailed elaboration of requirements and to support the identification of any potential system requirements at a later stage.

#	Business Process	Sub-Category	Requirement Description	Role	Rationale
REQ-01.01	01 Initialize Schedule	Maintain Schedule	Develop an initial migration schedule (MHHS Migration schedule v1) that aligns with system thresholds and capacity. (Weekly Granularity)	MCC	Ensures that the MHHS Migration schedule v1 is developed early with information available to allow relevant Participants planning and resourcing.
REQ-01.02	01 Initialize Schedule	Data Collection	Set up a system for participants to submit their migration preferences and migration plans	Industry Participants MCC	Allow MCC to systematically collect and validate Migration Plans from Participants in a deterministic, efficient and robust manner.
REQ-01.03	01 Initialize Schedule	Fairness	Ensure the initial MHHS Migration schedule v1 reflects a fair pragmatic allocation of available migration capacity.	MCC	Aligns with MFW Principles and included an intelligent pragmatic way to support Participant with lower volume portfolios that may otherwise be disadvantaged by a model that is primarily designed for large Supplier and LDSOs.
REQ-02.01	02 Maintain Schedule	Maintain Schedule	Update the MHHS Migration schedule according to a pre-agreed Sprint cadence to reflect changes in participant qualification and readiness status, migration outturn, and customer impacts.	MCC	Keeps the MHHS Migration schedule current and reflective of current Market conditions and evolving Participants needs.
REQ-02.02	02 Maintain Schedule	Data Collection	Implement a feedback mechanism/protocol for participants to communicate issues impacting their schedule in a timely manner.	Industry Participants MCC	Enables the MCC to make rapid, informed decisions and take timely corrective action on potential/actual MHHS Migration schedule impacts.
REQ-02.03	02 Maintain Schedule	Fairness	Ensure the schedule revisions adhere to the Migration Framework Principles including fairness and transparency.	MCC	Aligns with MFW Principles and ensures continuity during migration window.
REQ-03.01	03 Manage Sprint Execution	Data Collection, Oversight	Automated gathering and processing of information to digest and interpret migration progress and schedule adherence.	MCC	Allows for proactive management and early detection of emerging risks and issues.
REQ-03.02	03 Manage Sprint Execution	Oversight	Create a system for participants to report schedule deviations for timely MCC intervention.	Industry Participants MCC	Facilitates swift resolution of deviations to minimize impact on the migration timeline.
REQ-04.01	02 Maintain Schedule 03 Manage Sprint Execution	Capacity Adjustment and Reallocation	Design a system that dynamically adjusts capacity allocations based on real-time migration data.	MCC	Provides clear mechanism to apportion identified spare capacity to Participants that are able to <b>NOTE:</b> There primary reallocation will initiate soon after the MHHS Migration schedule is issued. However, some exceptional scenarios may be at relatively short notice e.g. 2-3 days.
REQ-04.02	02 Maintain Schedule 03 Manage Sprint Execution	Capacity Adjustment and Reallocation	Establish a process for participants to request extra capacity or return unused capacity for reallocation.	Industry Participants MCC	Implementation of a set of pre-agreed rules for unused capacity allocation.
REQ-05.01	04 Data Analytics and Reporting	Data Dissemination	Develop a dashboard for migration analytics, including progress, capacity, and metrics measuring Migration outturn against plan.	MCC	Provides stakeholders at the various levels required with actionable insights into migration operations.
REQ-05.02	04 Data Analytics and Reporting	Data Dissemination	Implement a reporting system to generate and distribute detailed migration status reports, including deviations and actions taken.	MCC	Keeps stakeholders informed and maintains transparency throughout the migration process.

#	Business Process	Sub-Category	Requirement Description	Role	Rationale
REQ-06.01	05 Close Down Migration	Closure	Confirm M15 Acceptance Criteria with Programme. Review and Report on end of Migration Decommission and disband migration related people, processes and technology.	MCC	To ensure all migrations have been successfully completed, to support the formal approval of the M15 milestone and initiation of closure activities.

## 6 Business Process Models

### 6.1 Level 0: MCC and Migration Schedule

#### 6.1.1 Level 0: MCC and Migration Schedule (BPM)

The figure below shows the high-level interactions and stages of the Migration Control Centre (MCC)

The Level 0 processes are described in Section: Level 0: MCC and Migration Schedule (BPM Description)

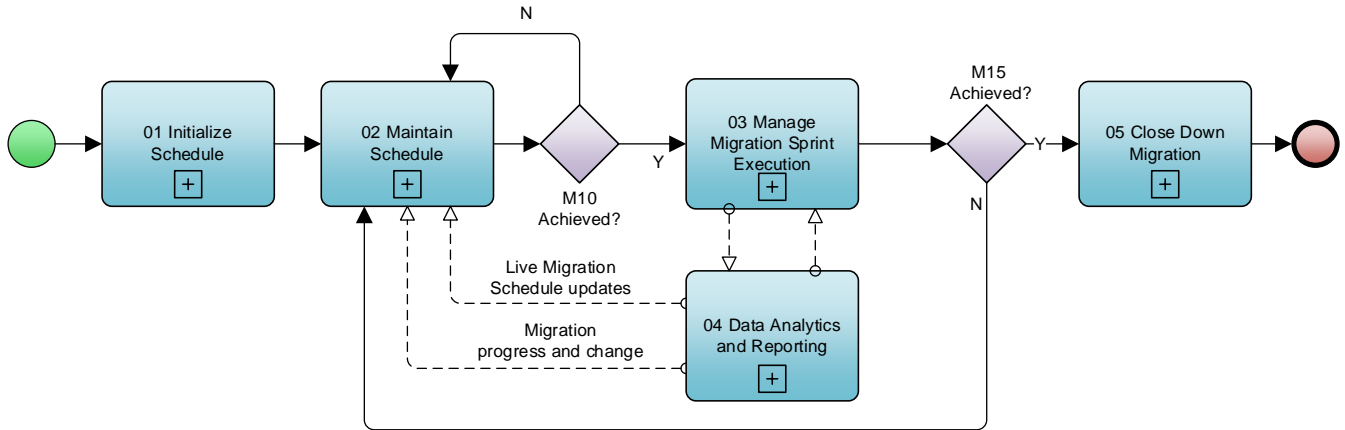

Figure 2 - Level 0 Business Process Model for MCC and Migration Schedule

6.1.2 Level 0: MCC and Migration Schedule (BPM Description)

NOTE: Processes shaded grey in the table will be detailed in upcoming consultations, the current descriptions are preliminary.

#	Process Name	Input	Process Details	Output
01	<b>Initialize Schedule</b>	<ul style="list-style-type: none"> <li>Finalised migration framework</li> <li>Qualification Dates</li> <li>Supplier Preferences</li> <li>Migration Plans at                             <ul style="list-style-type: none"> <li>Supplier (MPID) and LDSO(MPID) Level</li> <li>Weekly Granularity</li> <li>Indication of MPAN type distribution</li> </ul> </li> </ul>	<p><b>Following MFW:</b></p> <ul style="list-style-type: none"> <li>Create Supplier Capacity Envelopes to indicate capacity available to each Supplier</li> <li>Process Supplier Migration plan to generate MHHS Migration Schedule v1.</li> <li>Distribute to Participants</li> </ul>	<ul style="list-style-type: none"> <li>MHHS Migration Schedule v1</li> </ul>
02	<b>Maintain Schedule</b>	<ul style="list-style-type: none"> <li>Updated Supplier Plans (based in MCC Supplier Capacity Envelope updates)</li> <li>Daily/Weekly Granularity plans following MFW</li> <li>Quantified Impact to Migration schedule from the Control and Monitor Process including.</li> <li>Migration Outturn</li> <li>Migration and related systems performance</li> <li>Migration Progress/plan deviation</li> <li>Unused Capacity Allocations</li> </ul>	<p><b>Following MFW:</b></p> <ul style="list-style-type: none"> <li>Regularly update MHHS Migration Schedule following Migration Sprint Timeline.</li> <li>Regularly review and update the schedule to accommodate changes and incorporate:</li> <li>Migration progress.</li> <li>Participant qualification and readiness including migration start dates and service activation schedule.</li> <li>Service performance.</li> <li>Changes to supplier migration plans By re-issuing Supplier Capacity Envelopes and receiving updated Migration Plans within revised migration capacity restrictions.</li> <li>Suppliers provide/update list of MHHS Quantified Agents to be involved in their Migration Plans.</li> </ul>	<ul style="list-style-type: none"> <li>Next iteration of MHHS Migration Schedule.</li> <li>Data to inform 03 Control and Monitor.</li> <li>Data to inform Manage Unused Capacity Allocation.</li> <li>Data for 05 Data Analytics and Reporting.</li> </ul>
03	<b>Manage Sprint Execution</b>	<ul style="list-style-type: none"> <li>Supplier Daily Migration Plans</li> <li>Migration progress/performance data</li> <li>Service Management reports</li> <li>Notice of significant events potentially impacting migration schedule</li> <li>Significant plan deviations</li> <li>Participants behaving outside of MFW Principles</li> <li>Spare/Unused capacity details</li> <li>In-flight (for current Migration Execution) Unused Capacity Requests</li> <li>Additional Capacity Requests from Suppliers</li> </ul>	<ul style="list-style-type: none"> <li>Monitor migration activities</li> <li>Manage deviations through control mechanisms.</li> <li>Communicate migration status and trends.</li> <li>Unused Capacity Allocation Request Process.</li> <li>Allocate Unused Capacity calculation and disseminate Unused Capacity allocations.</li> <li>Ad-hoc process to allocates short-notice availability of spare capacity.</li> </ul>	<ul style="list-style-type: none"> <li>Deviation management updates.</li> <li>Issue escalations to Programme / Code Bodies as appropriate.</li> <li>Supplier daily capacity allocations as part of Migration Schedule Sprint Cadence.</li> <li>Ad-hoc daily capacity allocations.</li> </ul>
04	<b>Data Analytics and Reporting</b>	<ul style="list-style-type: none"> <li>Migration data, stakeholder feedback</li> <li>Same as Control and Monitor</li> </ul>	<ul style="list-style-type: none"> <li>Analyse migration data for insights; generate and distribute reports on status, deviations, and performance.</li> </ul>	<ul style="list-style-type: none"> <li>Regular/frequent monitoring reports.</li> <li>Migration analytics.</li> <li>Dashboards.</li> </ul>
05	<b>Close Down Migration</b>	<ul style="list-style-type: none"> <li>M15 Milestone confirmation</li> <li>Migration Reports</li> </ul>	<ul style="list-style-type: none"> <li>Close-down reporting, decommission MCC and finalise documentation.</li> </ul>	<ul style="list-style-type: none"> <li>Decommissioned MCC systems.</li> <li>Final Migration Reports and project closure.</li> </ul>

## 7 Level 1: 01 Initialise Schedule-(BPM)

The Level 1 processes (in blue) are the primary interactions with the MCC and are described in Section: Level 1: 01 Initialise Schedule-(BPM Descriptions).

NOTE: The processes (in white) are indicative process step where the process name conveys the expected activity.

For a higher resolution version of the model below:

- See MHHS-DEL2431-[04a] Migration Business Process Models

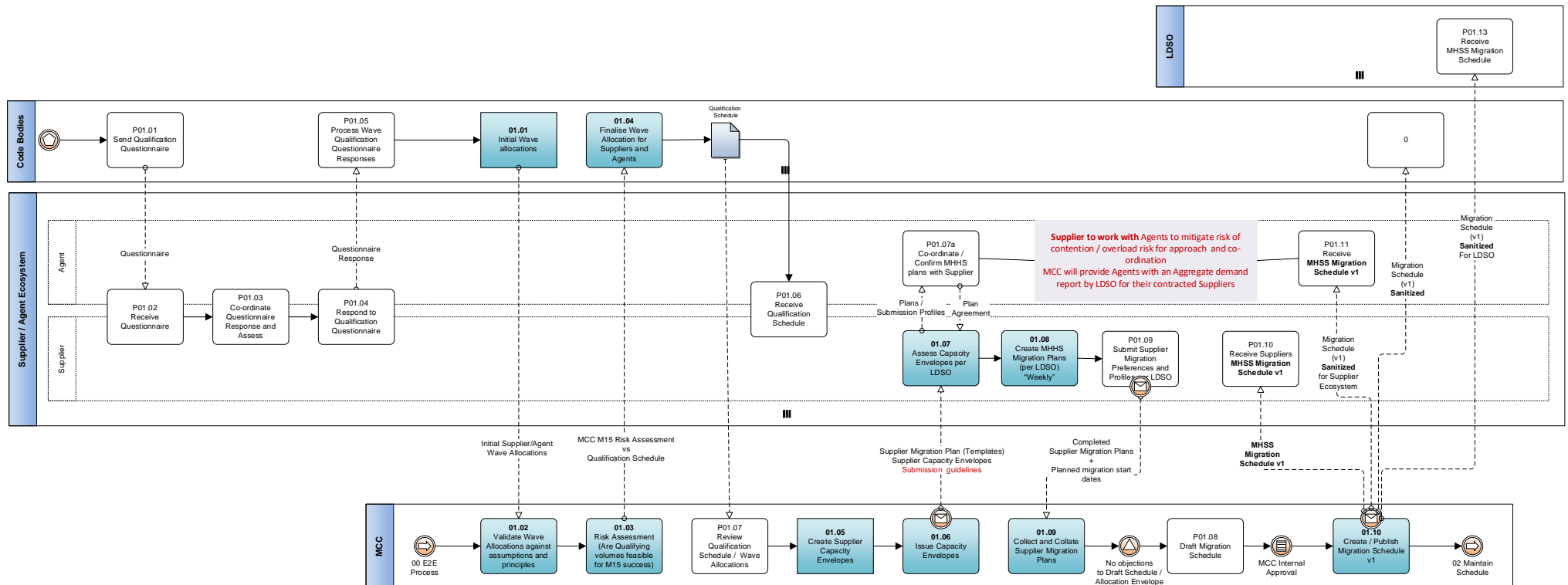

Figure 3 - Level 1 BPM - 01-Initialise Schedule

7.1 Level 1: 01 Initialise Schedule-(BPM Descriptions)

#	Process Name	Role	Input	Process Details	Output
1.01	Initial Wave allocations	Code Bodies	<ul style="list-style-type: none"> <li>Upstream industry consultation.</li> </ul>	<ul style="list-style-type: none"> <li>Early sight of Wave allocation to allow early identification of potential migration scheduled conflicts.</li> </ul>	<ul style="list-style-type: none"> <li>Initial Supplier/Agent Wave Allocations.</li> </ul>
1.02	Validate Wave Allocations against assumptions and principles	MCC	<ul style="list-style-type: none"> <li>Initial Supplier/Agent Wave Allocations.</li> </ul>		
1.03	Risk Assessment (Are Qualifying volumes feasible for M15 success)	MCC	<ul style="list-style-type: none"> <li>Reviewed Supplier/Agent Wave Allocations.</li> </ul>	<ul style="list-style-type: none"> <li>Risk Mitigation step to provide an initial view of impact of Qualification timeline on M15 feasibility.</li> </ul>	<ul style="list-style-type: none"> <li>MCC M15 Risk Assessment vs Qualification Schedule.</li> </ul>
1.04	Finalise Wave Allocation for Suppliers and Agents	Code Bodies	<ul style="list-style-type: none"> <li>MCC M15 Risk Assessment vs Qualification Schedule.</li> </ul>		<ul style="list-style-type: none"> <li>Confirmed Qualification Wave details</li> </ul>
1.05	Create Supplier Capacity Envelopes	MCC	<ul style="list-style-type: none"> <li>Confirmed Qualification Wave details.</li> </ul>	<ul style="list-style-type: none"> <li>Use Supplier Preference, Migration Plans with Supplier Capacity Allocation Method to define ALL Suppliers Capacity Envelopes at an LDSO Level.</li> </ul>	<ul style="list-style-type: none"> <li>Supplier Capacity Envelopes</li> </ul>
1.06	Issue Capacity Envelopes	MCC	<ul style="list-style-type: none"> <li>Supplier Capacity Envelopes .</li> </ul>	<ul style="list-style-type: none"> <li>Send each Supplier their generated plans in pre-agreed format.</li> </ul>	<ul style="list-style-type: none"> <li>Supplier Capacity Envelopes .</li> <li>Supplier Migration Plan. (Templates)</li> <li>Submission guidelines.</li> </ul>
1.07	Assess Capacity Envelopes per LDSO	Supplier	<ul style="list-style-type: none"> <li>Supplier Capacity Envelopes</li> </ul>	<ul style="list-style-type: none"> <li>Review Supplier MHHS Migration plans and confirm in-line with Migration Framework Principles.</li> </ul>	<ul style="list-style-type: none"> <li>Migration Submission Boundaries (Daily).</li> </ul>
1.08	Create MHHS Migration Plans (per LDSO)	Supplier	<ul style="list-style-type: none"> <li>Supplier Capacity Envelopes.</li> <li>Supplier Migration Plan (Templates).</li> <li>Submission guidelines.</li> </ul>	<ul style="list-style-type: none"> <li>As required create or adapt Suppliers' own Migration Submission Schedule within boundaries defined in the Suppliers' Capacity Envelopes.</li> </ul>	<ul style="list-style-type: none"> <li>Completed Supplier Migration Plans.</li> <li>Planned migration start dates.</li> </ul>
1.09	Collect and Collate Supplier Migration Plans	MCC	<ul style="list-style-type: none"> <li>Supplier Migration Plans</li> <li>Supplier / Agent Planned migration start date.</li> </ul>	<ul style="list-style-type: none"> <li>MPMT Stores all Suppliers Migration Plans with profile data.</li> </ul>	<ul style="list-style-type: none"> <li>Stored Supplier Migration Plans and Profiles per LDSO.</li> </ul>
1.10	Create / Publish Migration Schedule v1	MCC	<ul style="list-style-type: none"> <li>Stored Supplier Migration Plans and Profiles per LDSO.</li> </ul>	<ul style="list-style-type: none"> <li>Process Supplier Migration Plans in accordance with their Profile data and preference. Generate a balanced MHHS Migration Schedule following the MFW Principles.</li> </ul>	<ul style="list-style-type: none"> <li>Confirmed and rebalanced Migrations Plan (if required).</li> <li>Supplier Migration Plans per LDSO.</li> <li>MHSS Migration Schedule v1.</li> <li>Summary / Aggregate sanitized plans sent to LDSOs, Code Bodies and other Participants with permission to view.</li> </ul>

## 8 Level 1: 02 Maintain Schedule-(BPM)

The Level 1 processes (in blue) are the primary interactions with the MCC and are described in Section: Level 1: 02 Maintain Schedule-(BPM Description)..

NOTE: The processes (in white) are indicative process step where the process name conveys the expected activity.

For a higher resolution version of the model below: See MHHS-DEL2431-[04a] Migration Business Process Models

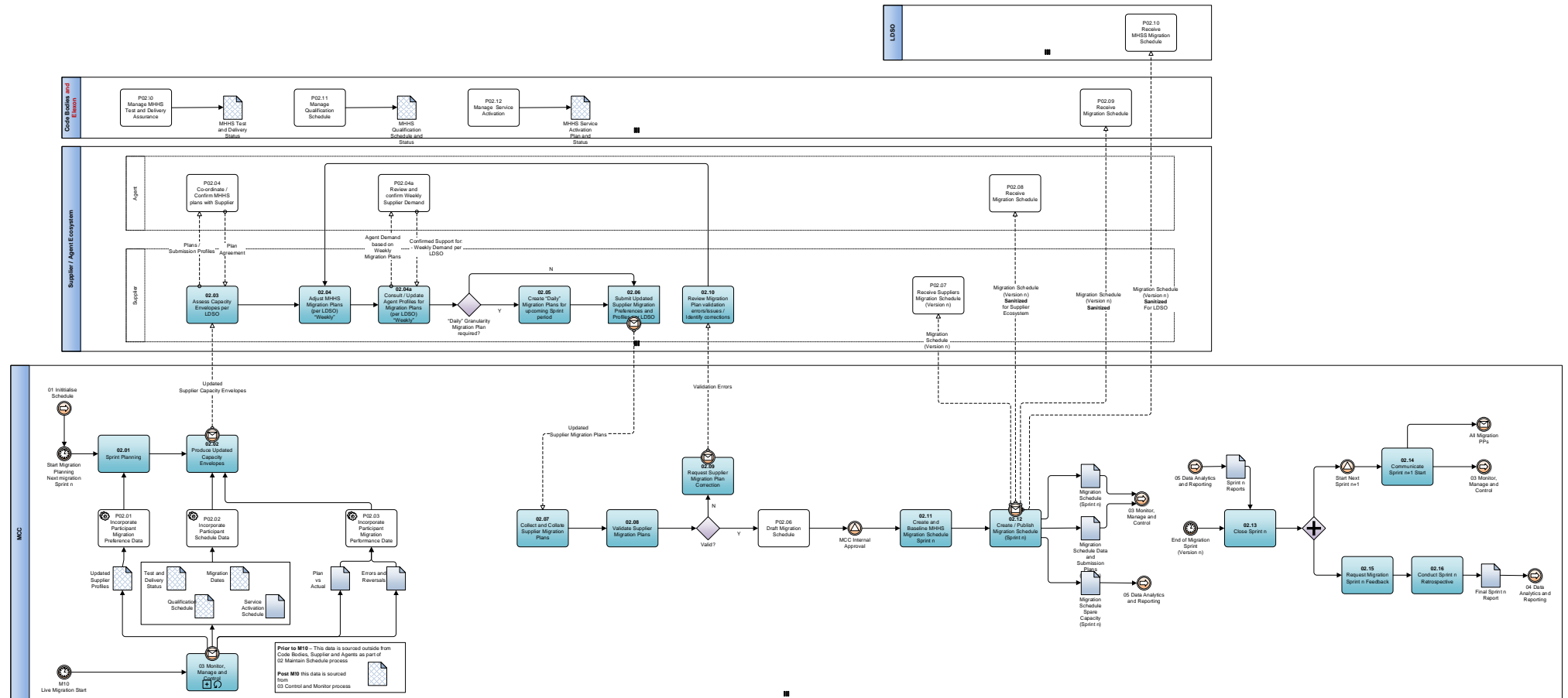

Figure 4 - Level 1 BPM - 02 Maintain Schedule

**8.1 Level 1: 02 Maintain Schedule-(BPM Description)**

#	Process Name	Role	Input	Process Details	Output
02.01	<b>Sprint Planning</b>	<b>MCC</b>	<ul style="list-style-type: none"> <li>Start of new sprint signal.</li> <li>Feedback from previous sprint.</li> </ul>	<ul style="list-style-type: none"> <li>The MCC initiates sprint planning by reviewing previous sprint feedback and signalling the start of a new sprint planning phase.</li> </ul>	<ul style="list-style-type: none"> <li>Sprint Planning Kick-off Notification.</li> </ul>
02.02	<b>Produce Updated Capacity Envelopes</b>	<b>MCC</b>	<ul style="list-style-type: none"> <li>Service performance data.</li> <li>Qualification schedules.</li> <li>Previous sprint migration data.</li> <li>Stakeholder feedback.</li> </ul>	<ul style="list-style-type: none"> <li>Analyse various inputs to reassess and update the capacity envelopes according to data available.</li> </ul>	<ul style="list-style-type: none"> <li>Updated Supplier Capacity Envelopes.</li> <li>Update Supplier Deminimis Submission Rules.</li> </ul>
02.03	<b>Assess Capacity Envelopes per LDSO</b>	<b>Supplier</b>	<ul style="list-style-type: none"> <li>Updated Supplier Capacity Envelopes.</li> </ul>	<ul style="list-style-type: none"> <li>Suppliers review the new capacity envelopes against their operational capabilities and migration goals, identifying potential adjustments needed.</li> </ul>	<ul style="list-style-type: none"> <li>Supplier Capacity Review Report.</li> </ul>
02.04	<b>Adjust MHHS Migration Plans (per LDSO) "Weekly"</b>	<b>Supplier</b>	<ul style="list-style-type: none"> <li>Supplier Capacity Review Report.</li> </ul>	<ul style="list-style-type: none"> <li>Suppliers adjust their weekly migration plans based on the new capacity envelopes and their review, ensuring alignment with overall migration goals.</li> </ul>	<ul style="list-style-type: none"> <li>Adjusted Weekly Supplier Migration Plans.</li> </ul>
2.04a	<b>Consult / Update Agent Profiles for Migration Plans (per LDSO) "Weekly"</b>	<b>Supplier</b>	<ul style="list-style-type: none"> <li>Adjusted Weekly Supplier Migration Plans</li> <li>View of Agent Demand per LDSO.</li> </ul>	<ul style="list-style-type: none"> <li>Supplier consult with all agents on the current / updated view of demand expected for MHHS Migrations on weekly basis per LDSO.</li> <li>Agents review and provide confirmation of support for expected demand.</li> </ul>	<ul style="list-style-type: none"> <li>Updated Weekly Supplier Migration Plans with Agent demand completed.</li> <li>List of Agents with expected max overall volume demand from Supplier view.</li> </ul>
02.05	<b>Create "Daily" Migration Plans for upcoming Sprint period</b>	<b>Supplier</b>	<ul style="list-style-type: none"> <li>Adjusted Weekly Supplier Migration Plans.</li> </ul>	<ul style="list-style-type: none"> <li>Suppliers detail their migration activities in daily plans for the upcoming sprint, ensuring adherence to the adjusted weekly plans and capacity envelopes.</li> </ul>	<ul style="list-style-type: none"> <li>Daily Supplier Migration Plans for Sprint n.</li> </ul>
02.06	<b>Submit Updated Supplier Migration Preferences and Profiles per LDSO</b>	<b>Supplier</b>	<ul style="list-style-type: none"> <li>Daily Supplier Migration Plans for Sprint n.</li> </ul>	<ul style="list-style-type: none"> <li>Suppliers submit their detailed daily migration plans to the MCC for review and validation.</li> </ul>	<ul style="list-style-type: none"> <li>Submitted Supplier Migration Plans for Sprint n.</li> </ul>
02.07	<b>Collect and Collate Supplier Migration Plans</b>	<b>MCC</b>	<ul style="list-style-type: none"> <li>Submitted Supplier Migration Plans for Sprint n.</li> </ul>	<ul style="list-style-type: none"> <li>The MCC collects and organizes all submitted daily migration plans, preparing them for validation.</li> </ul>	<ul style="list-style-type: none"> <li>Collated Migration Plans for Sprint n.</li> </ul>
02.08	<b>Validate Supplier Migration Plans</b>	<b>MCC</b>	<ul style="list-style-type: none"> <li>Collated Migration Plans for Sprint n.</li> </ul>	<ul style="list-style-type: none"> <li>Review and validate the submitted plans against the migration framework, business rules, and capacity constraints.</li> </ul>	<ul style="list-style-type: none"> <li>Validation Report &amp; Request for Plan Corrections.</li> </ul>
02.09	<b>Request Supplier Migration Plan Correction</b>	<b>Supplier</b>	<ul style="list-style-type: none"> <li>Request for Plan Corrections.</li> </ul>	<ul style="list-style-type: none"> <li>Suppliers review any issues or errors highlighted by the MCC and make necessary corrections to their migration plans.</li> </ul>	<ul style="list-style-type: none"> <li>Corrected Supplier Migration Plans.</li> </ul>



#	Process Name	Role	Input	Process Details	Output
02.10	Review Migration Plan validation errors/issues / Identify corrections	MCC	<ul style="list-style-type: none"> <li>Corrected Supplier Migration Plans.</li> </ul>	<ul style="list-style-type: none"> <li>The MCC finalizes the migration schedule for Sprint n, incorporating all corrected supplier plans and ensuring alignment with the migration framework.</li> </ul>	<ul style="list-style-type: none"> <li>Baselined MHHS Migration Schedule for Sprint n.</li> </ul>
02.11	Create and Baseline MHHS Migration Schedule Sprint n	MCC	<ul style="list-style-type: none"> <li>Baselined MHHS Migration Schedule for Sprint n.</li> </ul>	<ul style="list-style-type: none"> <li>The finalised migration schedule for Sprint n is published and communicated to all stakeholders, including tailored versions for individual suppliers.</li> <li>Including aggregated Supplier plans to assist other participants capacity planning.</li> </ul>	<ul style="list-style-type: none"> <li>Published Migration Schedule for Sprint n.</li> </ul>
02.12	Create / Publish Migration Schedule (Sprint n)	MCC & Suppliers	<ul style="list-style-type: none"> <li>Published Migration Schedule for Sprint n.</li> </ul>	<ul style="list-style-type: none"> <li>Both MCC and suppliers monitor the execution of Sprint n against the published schedule, identifying any deviations or issues.</li> </ul>	<ul style="list-style-type: none"> <li>Migration Schedule (Sprint n).</li> <li>Migration Schedule Data and Submission Plans (Sprint n).</li> <li>Migration Schedule Spare Capacity (Sprint n).</li> </ul>
02.13	Close Sprint n	MCC	<ul style="list-style-type: none"> <li>End of Sprint n confirmed by MCC.</li> </ul>		<ul style="list-style-type: none"> <li>Trigger Sprint Closure processes and reports.</li> </ul>
02.14	Communicate Sprint n+1 Start	MCC	<ul style="list-style-type: none"> <li>Closure of Previous Sprint</li> </ul>		<ul style="list-style-type: none"> <li>Start of next Sprint</li> <li>Message to All PPs and next Sprint start</li> <li>Signal to Manage Sprint Execution Processes to start next Sprint</li> </ul>
02.15	Request Migration Sprint n Feedback	MCC	<ul style="list-style-type: none"> <li>Sprint n Execution Report</li> </ul>	<ul style="list-style-type: none"> <li>At the end of Sprint n, conduct a review to assess the sprint's effectiveness, collect feedback from all stakeholders, and identify areas for improvement.</li> </ul>	<ul style="list-style-type: none"> <li>Sprint n Review Report &amp; Stakeholder Feedback.</li> </ul>
02.16	Conduct Sprint n Retrospective	MCC	<ul style="list-style-type: none"> <li>Sprint n Review Report and Stakeholder Feedback</li> </ul>	<ul style="list-style-type: none"> <li>Utilize the insights and feedback from Sprint n to begin preparation for Sprint n+1 planning, ensuring continuous improvement.</li> </ul>	<ul style="list-style-type: none"> <li>Final Sprint n Report</li> <li>Retrospective improvement recommendations and actions.</li> </ul>

## 9 Level 1: 03 Manage Sprint Execution (BPM)

For a higher resolution version of the model below: See MHHS-DEL2431-[04a] Migration Business Process Models

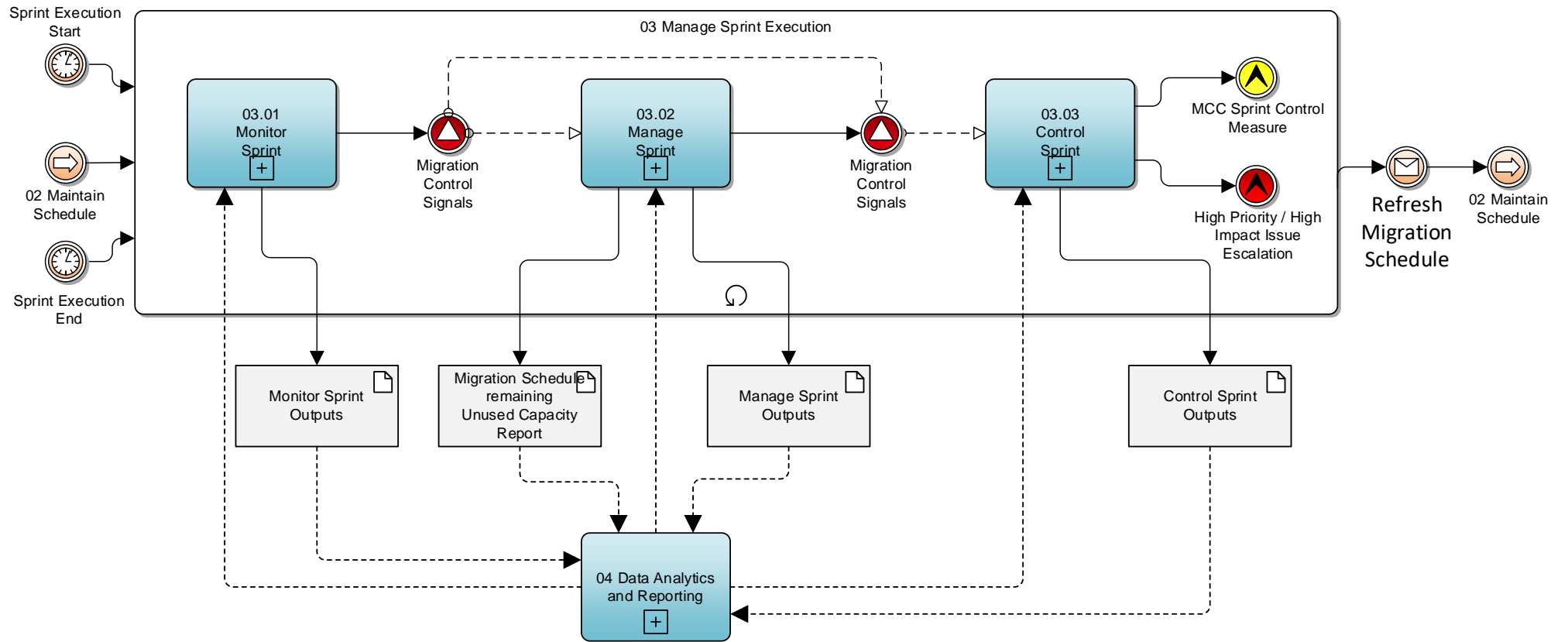

Figure 5 - Level 1 BPM - 03 Manage Sprint Execution

9.1 Level 1: 03 Manage Sprint Execution-(BPM Description)

#	Process Name	Role	Input	Process Details	Output
03.01	Monitor Sprint	MCC	<ul style="list-style-type: none"> <li>• Migration Schedule.</li> <li>• Migration Tracking.</li> <li>• Operational Reports.</li> </ul>	<ul style="list-style-type: none"> <li>• The MCC collects and analyses data from various sources to:                             <ul style="list-style-type: none"> <li>○ monitor sprint progress,</li> <li>○ generate reports,</li> <li>○ Provide information to identify potential issues or control signals that may require intervention.</li> </ul> </li> </ul>	<ul style="list-style-type: none"> <li>• Reports to Support Manage and Control Processes.</li> <li>• Migration Control Signals.</li> </ul>
03.02	Manage Sprint	MCC	<ul style="list-style-type: none"> <li>• Output from Monitor Sprint</li> <li>• Migration Control Signals.</li> </ul>	<ul style="list-style-type: none"> <li>• The MCC manages and resolves migration incidents, supplier issues, and deviations from supplier migration plans. It also handles the allocation of unused capacity during an in-flight sprint and manages migration-related requests and enquiries from suppliers.</li> </ul>	<ul style="list-style-type: none"> <li>• Reports to Support Control Processes.</li> <li>• Migration Control Signals.</li> </ul>
03.03	Control Sprint	MCC	<ul style="list-style-type: none"> <li>• Output from Monitor Sprint.</li> <li>• Output from Manage Sprint.</li> <li>• Migration Control Signals.</li> </ul>	<ul style="list-style-type: none"> <li>• The MCC reviews information and reports to determine the appropriate course of action, which may include                             <ul style="list-style-type: none"> <li>○ implementing control measures</li> <li>○ escalating high-priority issues to the relevant governance bodies</li> </ul> </li> <li>• The MCC also creates and updates status reports to keep stakeholders informed of the sprint progress and any actions taken.</li> </ul>	<ul style="list-style-type: none"> <li>• MCC Sprint Control Measure.</li> <li>• High Priority / High Impact Issue Escalation.</li> <li>• Signal to refresh Migration Schedule.</li> </ul>

9.2 Level 2: 03.01 Monitor Sprint (BPM)

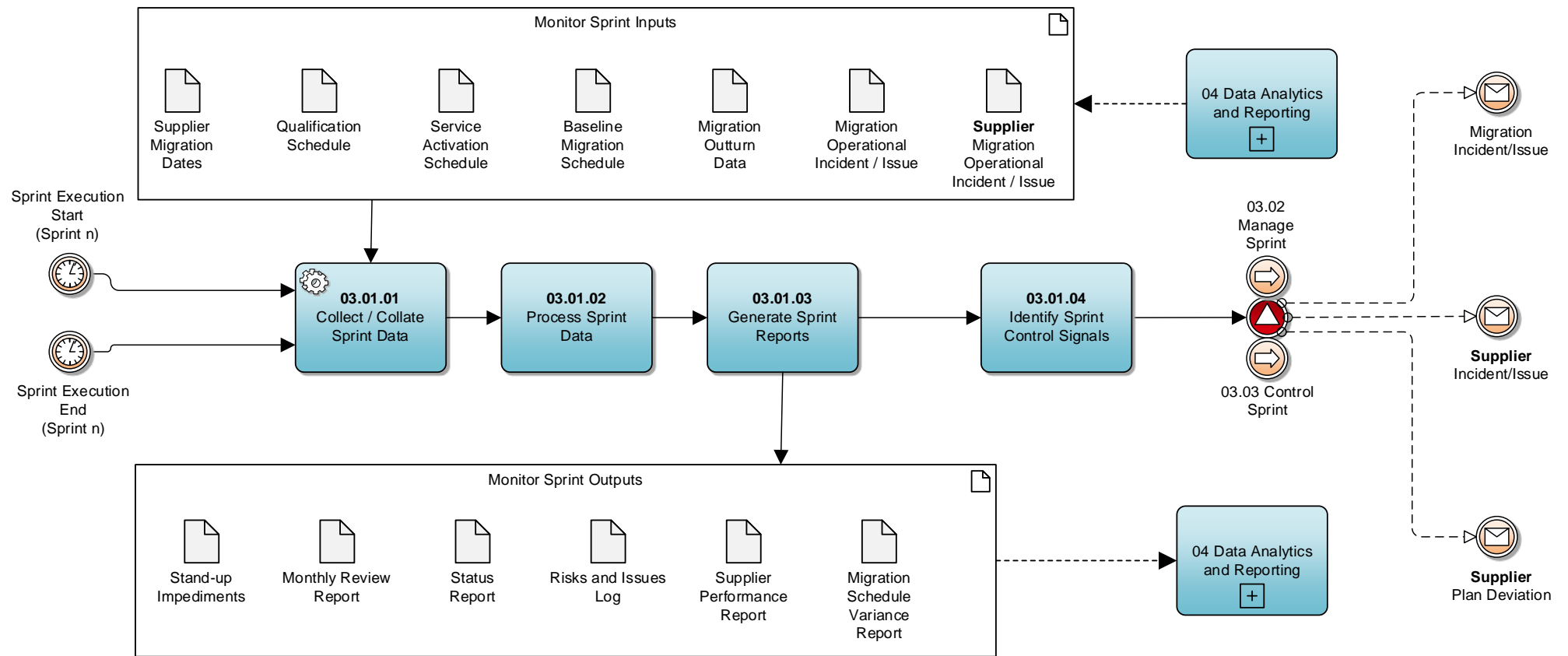

Figure 6 - Level 2 BPM – 03.01 Monitor Sprint

9.2.1 Level 2: 03.01 Monitor Sprint (BPM Description)

#	Process Name	Role	Input	Process Details	Output
03.01.01	Collect / Collate Sprint Data	MCC	<ul style="list-style-type: none"> <li>Inputs (Sourced from 04 Data Analytics and Reporting).</li> <li>Supplier Migration Dates</li> <li>Qualification Schedule.</li> <li>Service Activation Schedule.</li> <li>Baseline Migration Schedule.</li> <li>Migration Outturn Data.</li> <li>Migration Operational Incident / Issue.</li> <li>Supplier Migration Operational Incident / Issue</li> </ul>	<ul style="list-style-type: none"> <li>Collates data from various sources to monitor sprint progress and identify potential issues.</li> </ul>	<ul style="list-style-type: none"> <li>Structured Migration data and Sprint data for analysis.</li> </ul>
03.01.02	Process Sprint Data	MCC	<ul style="list-style-type: none"> <li>Structured Migration data and Sprint data for analysis.</li> </ul>	<ul style="list-style-type: none"> <li>Process and validate migration data, including reviews and clarifications.</li> </ul>	Outputs (Sent to 04 Data Analytics and Reporting)
03.01.03	Generate Sprint Reports	MCC	<ul style="list-style-type: none"> <li>Validated and curated Migration data and Sprint data.</li> </ul>	<ul style="list-style-type: none"> <li>Generate various reports based on the processed sprint data and migration data.</li> </ul>	<b>Monitor Sprint Outputs</b> <ul style="list-style-type: none"> <li>Stand-up Impediments</li> <li>Monthly Review Report</li> <li>Status Report</li> <li>Risks and Issues Log</li> <li>Supplier Performance Reports</li> <li>Migration Schedule Variance Reports</li> </ul>
03.01.04	Identify Sprint Control Signals	MCC	<ul style="list-style-type: none"> <li>Monitor Sprint Reports and data.</li> </ul>	<ul style="list-style-type: none"> <li>Review reports to identify control signals or events that may require management intervention or escalation.</li> </ul>	<b>Messages to 03.02 Manage Sprint:</b> <ul style="list-style-type: none"> <li>Migration Incident/Issue</li> <li>Supplier Incident/Issue</li> <li>Supplier Plan Deviation</li> </ul>
04	Data Analytics and Reporting	See REF-9 MHHS-DEL2764-[07] Migration Data Requirements and Reports v3.0			

9.3 Level 2: 03.02 Manage Sprint (BPM)

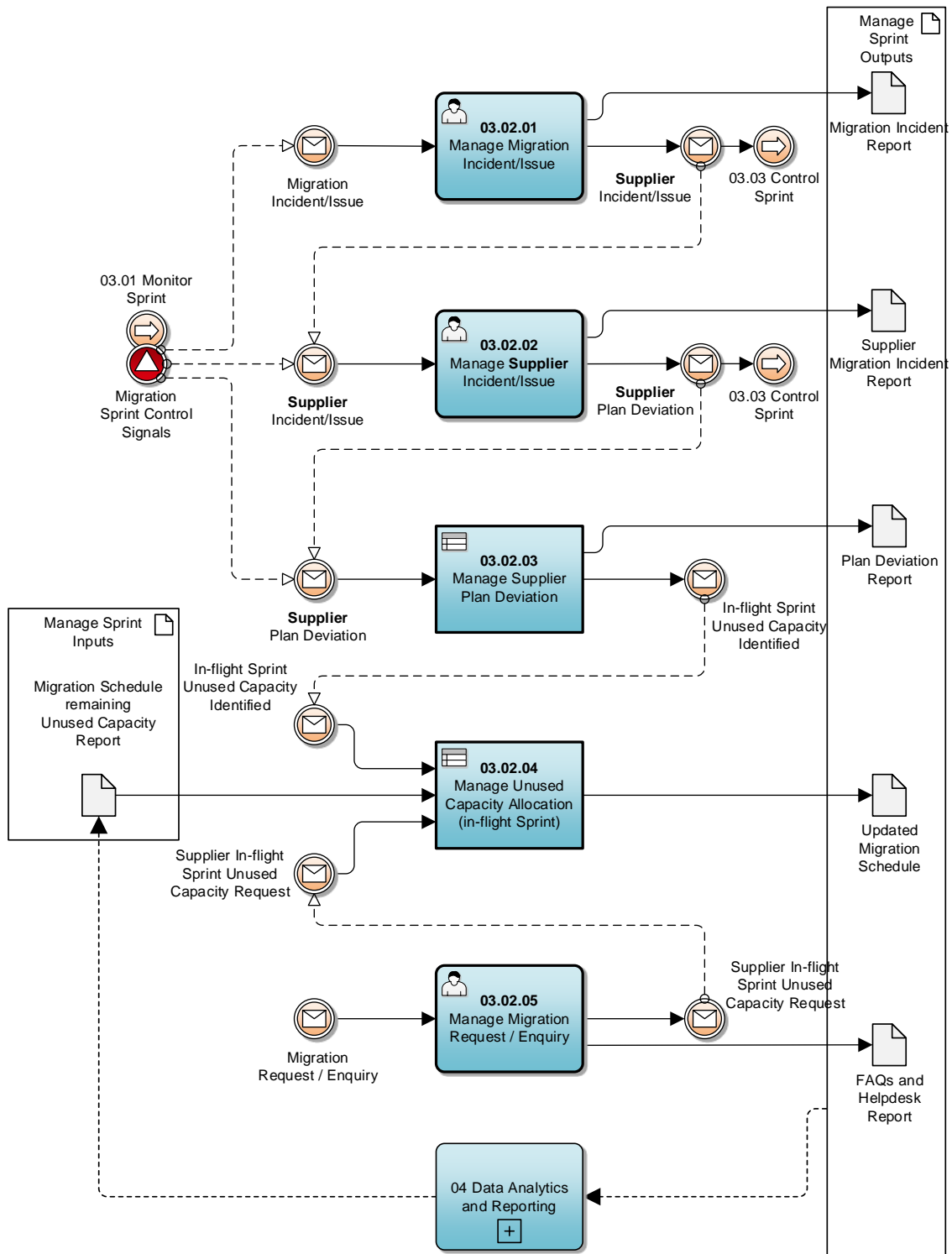

Figure 7 - Level 2 BPM – 03.02 Manage Sprint

9.3.1 Level 2: 03.02 Manage Sprint (BPM Description)

#	Process Name	Role	Input	Process Details	Output
03.02.01	Manage Migration Incident/Issue	MCC	Signal: • Migration Incident/Issue.	<ul style="list-style-type: none"> <li>• Triage Migration incident</li> <li>• Manages and seeks to identify next steps or resolve.</li> </ul>	<ul style="list-style-type: none"> <li>• Migration Incident Report.</li> </ul>
03.02.02	Manage Supplier Incident/Issue	MCC	Signal: • Supplier Incident/Issue.	<ul style="list-style-type: none"> <li>• Triage Supplier Migration incident.</li> <li>• Manages and seeks to identify next steps or resolve</li> <li>• Identify any Supplier deviations possibly related to incidents.</li> </ul>	<ul style="list-style-type: none"> <li>• Supplier Migration Incident Report.</li> <li>• Supplier Plan Deviation.</li> </ul>
03.02.03	Manage Supplier Plan Deviation	MCC	Signal: • Supplier Plan Deviation.	<ul style="list-style-type: none"> <li>• Manages deviations from supplier migration plans and identifies unused capacity</li> <li>• Generates deviation report.</li> </ul>	<ul style="list-style-type: none"> <li>• Plan Deviation Report.</li> <li>• In-flight Sprint Unused Capacity Identified.</li> </ul>
03.02.04	Manage Unused Capacity Allocation (in-flight Sprint)	MCC	<ul style="list-style-type: none"> <li>• Migration Schedule remaining Unused Capacity Report.</li> <li>• Supplier Unused Capacity Request.</li> </ul>	<ul style="list-style-type: none"> <li>• Communicate in-flight Unused capacity to eligible Suppliers.</li> <li>• Collect Unused Capacity requires.</li> <li>• Allocate available Unused Capacity based on requests.</li> </ul> <p>See Section 9.4 LEVEL 3: Ad-Hoc Unused Capacity Allocation (Process Description)</p>	<ul style="list-style-type: none"> <li>• Updated Migration Schedule.</li> <li>• Updated Unused Migration Capacity</li> </ul>
03.02.05	Manage Migration Request / Enquiry	MCC	<ul style="list-style-type: none"> <li>• General Enquiries</li> <li>• Supplier Unused Capacity Request.</li> </ul>	<ul style="list-style-type: none"> <li>• Manages migration-related requests and Enquiries.</li> </ul>	<ul style="list-style-type: none"> <li>• FAQs.</li> <li>• Guides.</li> <li>• Support Response.</li> <li>• Helpdesk Report.</li> </ul>
04	Data Analytics and Reporting	See 10 Level 1 Data Analytics and Reporting (BPM REF-4 MHHS-DEL2430 [04] Migration Requirements and Processes v3.0)			

**9.4 LEVEL 3: Ad-Hoc Unused Capacity Allocation (Process Description)**

The following steps outline the in-flight Ad-Hoc Unused Capacity Process referred to in Section 9.3.1 Level 2: 03.02 Manage Sprint (BPM Description), Manage Unused Capacity Allocation (in-flight Sprint).

REF	WHEN	ACTION	FROM	TO	INFORMATION REQUIRED/ RESPONSE PROVIDED	METHOD
1.0	According to the Sprint Schedule.	Send Unused Capacity Report.	MCC	Suppliers	Report detailing the unused capacity.	Portal
1.1	Following initial receipt of the Unused Capacity Report and within 5 days of the start of Sprint Execution or on any Working Day within a Sprint Execution and by 12:00 hrs Mid-day.	Request for Unused Capacity. Request must be for Migration Dates at least 2 Working Days in the future and within the current Sprint cycle.	Suppliers	MCC	Supplier Submission Template with Unused Capacity Request by LDSO.	Portal
1.2	By 12:00 Mid-day on WD+2	Collate Unused Capacity Requests and resolve any contention.	MCC			Internal Process
1.3	By 17:00 hrs on WD+2	Send Supplier confirmation of request outcome.	MCC	Requesting Supplier	Acceptance, Rejection or Constrained Submission. If Acceptance or Constrained Submission Updated Baseline of Supplier Submission Schedule	Portal
1.4	By 12:00 hrs Mid-day WD+1	Send Updated Unused Capacity Report.	MCC	Suppliers		Portal
1.5	By 12:00 hrs Mid-day WD+1	Notification of take up of Unused Capacity by Suppliers (Aggregate Summary of delta uplift)	MCC	LDSOs Central Services Agents	Changes to Current Migration Schedule for the current Sprint only where unused capacity has been taken up.	Portal



9.5 Level 2: 03.03 Control Sprint (BPM)

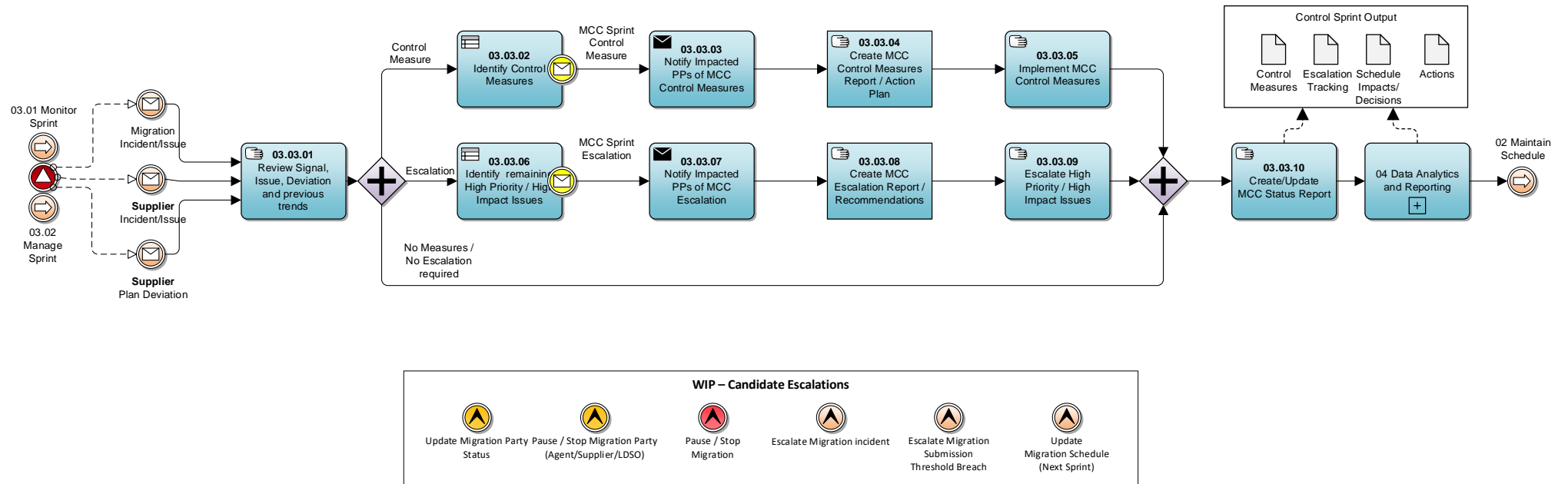

Figure 8 - Level 2 BPM – 03.03 Control Sprint

9.5.1 Level 2: 03.03 Control Sprint (Escalations (WIP))

#	Escalation	Description	Example Triggers
ES-01	Update Migration MCC Party Status	Update status of a migration party (Agent, Supplier, or LDSO) based on their performance, compliance, or other relevant factors during the migration process.	<ul style="list-style-type: none"> <li>• Consistent underperformance or non-compliance with migration plans.</li> <li>• Failure to resolve critical issues within agreed timelines.</li> <li>• Significant risks or impacts to the overall migration timeline.</li> </ul> <p>Update MCC Party Status as required:</p> <ul style="list-style-type: none"> <li>- Compliant.</li> <li>- At Risk.</li> <li>- Escalated beyond MCC.</li> </ul> <p>MCC Measures Applied.</p>
ES-02	Pause / Stop Migration Party	Temporarily pausing or permanently stopping the migration activities of a specific migration party.  The MCC determines that the migration party's continuation poses significant risks to the Programme in agreement with TBC.	<ul style="list-style-type: none"> <li>- Severe and persistent issues or non-compliance</li> <li>- Failure to adhere to the remediation plan.</li> <li>- Significant risks or impacts to the overall migration timeline or other migration parties.</li> </ul>
ES-03	Pause / Stop Migration	Temporarily pausing or permanently stopping the entire migration process due to severe issues, risks, or external factors that jeopardise the overall programme. <ul style="list-style-type: none"> <li>• Continuing the migration poses significant risks or is no longer feasible.</li> <li>• Instruction from other Programme Body potentially after MCC escalation.</li> </ul>	<ul style="list-style-type: none"> <li>- Severe and widespread issues or risks impacting multiple migration parties.</li> <li>- Significant external factors or dependencies that prevent the continuation of migration.</li> <li>- Major programme-level risks or issues that require immediate attention.</li> <li>- Severe Central Service outage for a sustained period.</li> </ul>
ES-04	Escalate Migration Incident	Raising a critical migration incident to higher levels of governance and management for immediate attention and resolution.	<ul style="list-style-type: none"> <li>- High-impact incidents that severely affect the migration process or multiple parties.</li> <li>- Incidents with significant risks or consequences to the programme objectives.</li> <li>- Incidents that require immediate attention and resolution from higher levels of governance.</li> </ul>
ES-05	Escalate Supplier Migration Submission Threshold Breach	Breach of migration submission thresholds to higher levels of governance and management for review and action.	<p>See REF-8 MHHS-DEL2763-[06] Migration Governance and Escalation Framework v3.0</p> <ul style="list-style-type: none"> <li>- Migration submissions exceeding or falling short of the defined thresholds.</li> <li>- Deviations that impact the overall migration timeline or capacity planning.</li> <li>- Repeated or systemic breaches of submission thresholds by migration parties.</li> </ul>
ES-06	Update Migration Schedule (Next Sprint)	MCC decides to update the migration schedule allocations for the next sprint based on the outcomes, issues, and escalations from the current sprint. Scaling Factors or other changes may be applied at Supplier MPID level or more widely dependant on the underlying cause the changes are intended to mitigate.	<ul style="list-style-type: none"> <li>- Significant deviations or issues identified during the current sprint.</li> <li>- Changes in a migration party readiness or capacity.</li> <li>- External factors or dependencies that impact the migration timeline.</li> <li>- Recommendations from the governance bodies or management based on escalations.</li> </ul>

9.5.2 Level 2: 03.03 Control Sprint (BPM Description)

#	Process Name	Role	Input	Process Details	Output
03.03.01	Review Signal, Issue, Deviation and previous trends	MCC	<ul style="list-style-type: none"> <li>• Signals from Sub-Process 03.01 Monitor Sprint.</li> <li>• Signals from Sub-Process 03.02 Manage Sprint.</li> <li>• Migration Incident/Issue.</li> <li>• Supplier Incident/Issue.</li> <li>• Supplier Plan Deviation.</li> </ul>	<ul style="list-style-type: none"> <li>• Review signals, issues, and deviations, along with previous trends, to determine the appropriate course of action.</li> </ul>	<ul style="list-style-type: none"> <li>• Control Measure.</li> <li>• Escalation.</li> <li>• No Measures / No Escalation required.</li> </ul>
<b>Path- -Control Measure</b>					
03.03.02	Identify Control Measures/ message: MCC Sprint Control Measure	MCC	<ul style="list-style-type: none"> <li>• Review outcomes requiring control measures.</li> </ul>	<ul style="list-style-type: none"> <li>• Identify control measures to address the identified issues or deviations.</li> </ul>	<ul style="list-style-type: none"> <li>• MCC Sprint Control Measure.</li> </ul>
03.03.03	Notify Impacted PPs of MCC Control Measures	MCC	<ul style="list-style-type: none"> <li>• Identified control measures.</li> </ul>	<ul style="list-style-type: none"> <li>• Notify impacted program participants (PPs) of the MCC control measures.</li> </ul>	<ul style="list-style-type: none"> <li>• Notification of MCC Control Measures.</li> </ul>
03.03.04	Create MCC Control Measures Report / Action Plan	MCC	<ul style="list-style-type: none"> <li>• Identified control measures.</li> </ul>	<ul style="list-style-type: none"> <li>• Create implementation plan / actions for the MCC control measures to mitigate issues and manage deviations, migration risks, or migration issues.</li> </ul>	<ul style="list-style-type: none"> <li>• Implementation Plan / Actions for MCC Control Measures.</li> </ul>
03.03.05	Implement MCC Control Measures	MCC	<ul style="list-style-type: none"> <li>• Identified control measures</li> <li>• Implementation Plan / Actions for MCC Control Measures.</li> </ul>	<ul style="list-style-type: none"> <li>• Initiate implementation of MCC Control Measure and tracking until resolved</li> <li>• May require co-ordination with additional Parties / Bodies to complete plan.</li> </ul>	<ul style="list-style-type: none"> <li>• Implemented Control Measures.</li> </ul>
<b>Path- -Escalation</b>					
03.03.06	Identify remaining High Priority / High Impact Issues	MCC	<ul style="list-style-type: none"> <li>• Review outcomes requiring escalation.</li> </ul>	<ul style="list-style-type: none"> <li>• Identify high priority or high impact issues that require escalation.</li> </ul>	<ul style="list-style-type: none"> <li>• MCC Sprint Escalation.</li> </ul>
03.03.07	Notify Impacted PPs of MCC Escalation	MCC	<ul style="list-style-type: none"> <li>• Identified escalation issues.</li> </ul>	<ul style="list-style-type: none"> <li>• Notify impacted program participants (PPs) of the MCC escalation.</li> </ul>	<ul style="list-style-type: none"> <li>• Notification of MCC Escalation.</li> </ul>
03.03.08	Create MCC Escalation Report / Recommendations	MCC	<ul style="list-style-type: none"> <li>• Escalated Issues.</li> </ul>	<ul style="list-style-type: none"> <li>• Create a report or recommendations based on the escalated issues.</li> </ul>	<ul style="list-style-type: none"> <li>• MCC Escalation Report / Recommendations.</li> </ul>
03.03.09	Escalate High Priority / High Impact Issues	MCC	<ul style="list-style-type: none"> <li>• Escalated Issues</li> <li>• MCC Escalation Report / Recommendations.</li> </ul>	<ul style="list-style-type: none"> <li>• Escalates high priority or high impact issues to the appropriate governance bodies.</li> </ul>	<ul style="list-style-type: none"> <li>• Escalated Issues.</li> <li>• MCC Escalation Report / Recommendations.</li> </ul>
<b>All Paths including No Measures/No Escalation</b>					
03.03.10	Create/Update MCC Status Report	MCC	<ul style="list-style-type: none"> <li>• MCC Escalation Report / Recommendations.</li> <li>• Implementation Plan / Actions for MCC Control Measures.</li> <li>• Schedule Impacts/Decisions.</li> </ul>	<ul style="list-style-type: none"> <li>• Creates or updates the MCC Status Report, consolidating information from control measures, escalations, and other relevant sources.</li> </ul>	<ul style="list-style-type: none"> <li>• MCC Status report including</li> <li>• Measures</li> <li>• Escalations.</li> <li>• Parties at Risk</li> <li>• Schedule .Amendments as a result of MCC Control Measures.</li> </ul>
04	Data Analytics and Reporting	See 10 Level 1 Data Analytics and Reporting (BPM REF-4 MHHS-DEL2430 [04] Migration Requirements and Processes v3.0			

## 10 Level 1: 04. Data Analytics and Reporting (BPM Description)

Reporting and Data Analytics Process include the following:

Revives Inputs and Data from and Supports the following processes:

- 02 Maintain Schedule
- 03 Manage Sprint Execution Processes

Process operated and managed by the MCC to analyse, identify trend, and generate reports to be used elsewhere in Migration including

- REF-05 MHHS-DEL2762-[05] Migration Choreography
- REF-06-MHHS-DEL2763-[06] Governance and Escalation Framework

#	Process Name	Role	Input	Process Details	Output
04	Data Analytics and Reporting	MCC	Data collection from various sources, including: <ul style="list-style-type: none"> <li>• Migration data.</li> <li>• Sprint data.</li> <li>• Industry data.</li> <li>• Regulatory data.</li> <li>• Operational data.</li> </ul>	<ul style="list-style-type: none"> <li>• Collecting and aggregating migration-related data from multiple sources.</li> <li>• Conducting analysis of the collected data to derive insights</li> <li>• Identifying patterns, trends, anomalies, and potential risks in the migration process.</li> <li>• Generating reports and dashboards and where required present findings.</li> <li>• Disseminating the reports and insights to stakeholders.</li> <li>• Provide a foundation for data-driven decision-making and ensuring transparency throughout migration.</li> </ul>	The outputs of the Data Analytics and Reporting process empower the MCC and stakeholders to: <ul style="list-style-type: none"> <li>• Monitor migration progress against planned timelines and milestones.</li> <li>• Identify and mitigate risks and issues proactively.</li> <li>• Assess supplier performance and compliance.</li> <li>• Make informed decisions based on data-driven insights.</li> <li>• Communicate migration status and outcomes effectively to all stakeholders.</li> </ul>

## 11 Level 1: 05. Close Down Migration (BPM)

**NOTE:**

- This process is indicative only
- This process will be elaborated and redefined at a later stage closer to the M14 Milestone

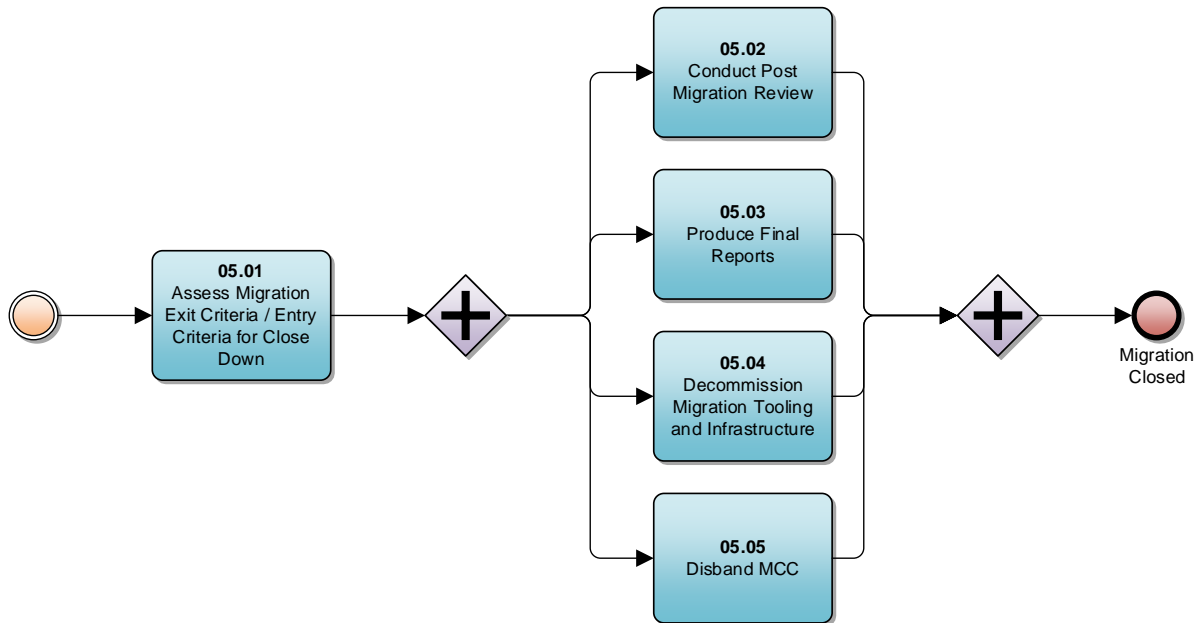

Figure 9 - Level 1 BPM – 05 Close Down Migration

### 11.1 Level 1: 05. Close Down Migration (BPM Description)

#	Process Name	Role	Input	Process Details	Output
05.01	Assess Migration Exit Criteria / Entry Criteria for Close Down	MCC	<ul style="list-style-type: none"> <li>• All Migrations Completed based on MHHS-DEL1792 - M15 Acceptance Criteria</li> <li>• M15 Milestone approved</li> <li>• Final Migration Reports Produced, including performance metrics and outstanding issues</li> <li>• Post-Migration Stability Period completion</li> </ul>	<ul style="list-style-type: none"> <li>• Review M15 milestone acceptance criteria and confirm all migrations are completed accordingly</li> <li>• Review migration reports and outstanding issues</li> </ul>	<ul style="list-style-type: none"> <li>• Approval to proceed with migration closure</li> </ul>
05.02	Conduct Post-Migration Review	MCC	<ul style="list-style-type: none"> <li>• Feedback from participants</li> <li>• MCC internal data</li> </ul>	<ul style="list-style-type: none"> <li>• Collect participant feedback</li> <li>• Document key learnings and compile best practices for future reference</li> </ul>	<ul style="list-style-type: none"> <li>• Post-Migration Review Report</li> <li>• Insights for future initiatives</li> </ul>
05.03	Produce Final Reports	MCC	<ul style="list-style-type: none"> <li>• Aggregated migration data</li> <li>• Performance metrics</li> <li>• Outstanding issues</li> </ul>	<ul style="list-style-type: none"> <li>• Generate and distribute aggregated final reports</li> <li>• Highlight migration outcomes, performance metrics, and unresolved issues</li> </ul>	<ul style="list-style-type: none"> <li>• Final Migration Reports</li> <li>• Inputs to overall programme closure</li> </ul>
05.04	Decommission Migration Tooling and Infrastructure	MCC	<ul style="list-style-type: none"> <li>• List of migration tooling and infrastructure components to decommission</li> </ul>	<ul style="list-style-type: none"> <li>• Conduct decommissioning activities</li> </ul>	<ul style="list-style-type: none"> <li>• Decommissioned migration tooling and infrastructure</li> </ul>

#	Process Name	Role	Input	Process Details	Output
05.05	Disband MCC	MCC	<ul style="list-style-type: none"><li>• Completion of all migration-related activities, reports and approvals</li></ul>	<ul style="list-style-type: none"><li>• Officially disband the MCC team</li><li>• Transition any ongoing responsibilities</li></ul>	<ul style="list-style-type: none"><li>• Formal closure of the MCC</li><li>• Transition plans</li></ul>

# 12 Appendix

## 12.1 MHHS Migration Business Process Model Notation Key













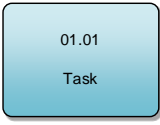
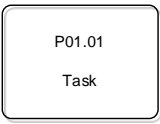
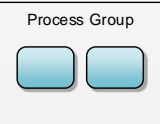

	<b>Start Event</b>		<b>Intermediate Event</b>		<b>End Event</b>
			<b>Process Link</b>		
			<b>Message Event</b>		
			<b>Multiple Triggers</b>		
			<b>Signal</b>		
	<b>Task:</b> This represents a specific action or step in the process				
	<b>Indicative Task:</b> Indicative activity to aid understanding and representative only				
	<b>Sub-Process:</b> A collapsed process comprised of a series of other tasks/processes				
	<b>Process Group:</b> An collapsed view of tasks and/or sub-processes				
	<b>Exclusive (XOR) Gateway:</b> Decision to go one way or another				
	<b>Parallel (AND) Gateway:</b> Initiate multiple steps				
	<b>Inclusive (OR) Gateway:</b> Offers multiple paths but more flexible than the XOR				
	<b>Message Flow</b>				
	<b>Sequence Flow</b>				
	<b>Data Object</b>				

Figure 10 - Business Process Model Notation Key